



PREMA Radial Repairs – Agricultural

PREMA Radial Reparatur – Ackerschlepper

| Sidewall Injury | | | | | |
|-----------------|-----|-------------------------|-----|---|-----|
| | | | | | |
| Injury Size | | Agricultural Tire Sizes | | | |
| | | 8 - 11 8.3 - 12.4 | | 12 - 15 13.6 - 30.5 440/65 - 800/65 | |
| Width | | Length | | PR- | PR- |
| in | mm | in | mm | | |
| 1/4 | 6 | 1/4 | 6 | 112 | 112 |
| 3/8 | 10 | 3/8 | 10 | 112 | 112 |
| 3/8 | 10 | 1 1/2 | 40 | 120 | 120 |
| 3/4 | 20 | 3/4 | 20 | 120 | 120 |
| 3/4 | 20 | 3 | 75 | 122 | 180 |
| 1 1/2 | 40 | 3 | 75 | 180 | 182 |
| 2 | 50 | 3 1/4 | 80 | 182 | 182 |
| 2 1/2 | 65 | 3 | 75 | 182 | 182 |
| 2 1/2 | 65 | 4 | 100 | - | 182 |
| 2 3/4 | 70 | 2 3/4 | 70 | 182 | 182 |
| 3 1/4 | 80 | 3 1/4 | 80 | - | 182 |
| 3 1/4 | 80 | 5 1/4 | 130 | - | 184 |
| 3 1/2 | 90 | 4 1/2 | 115 | - | 184 |
| 4 | 100 | 4 | 100 | - | 184 |
| 4 | 100 | 6 1/2 | 165 | - | 186 |
| 5 1/4 | 130 | 5 1/4 | 130 | - | 186 |

| Crown Injury | | | | | |
|------------------------------|-----|-------------------------|-----|---|--|
| | | | | | |
| Crown Injury Diameter (max.) | | Agricultural Tire Sizes | | | |
| | | 8 - 11 8.3 - 12.4 | | 12 - 15 13.6 - 30.5 440/65 - 800/65 | |
| in | mm | PR- | PR- | | |
| 3/8 | 10 | 112 | 112 | | |
| 3/4 | 20 | 120 | 120 | | |
| 1 1/2 | 40 | 180 | 182 | | |
| 2 3/4 | 70 | 180 | 182 | | |
| 3 1/2 | 90 | - | 184 | | |
| 5 1/4 | 130 | - | 186 | | |

The **SHOULDER** is defined as 1 1/2 inches (40 mm) in from the outside edge of the tread footprint.

The **NON-REPAIRABLE AREA** is defined by the tire type/size as listed below.

| Tire Type or Size | Inch | mm |
|------------------------------------|-------|-----|
| Passenger & Light Truck (<1/2 ton) | 1 1/2 | 40 |
| 6.50 - 7.00 | 2 1/2 | 65 |
| 7.50 - 16.00 | 3 | 76 |
| 17.00 - 23.50 | 3 1/2 | 90 |
| 24.00 - 29.50 | 5 | 125 |
| 30.00 - 33.50 | 6 | 150 |
| 36.00 | 7 1/2 | 190 |
| 37.00 - 55/80 | 10 | 250 |

| Shoulder Injury | | | | | |
|---------------------------------|-----|-------------------------|-----|---|--|
| | | | | | |
| Shoulder Injury Diameter (max.) | | Agricultural Tire Sizes | | | |
| | | 8 - 11 8.3 - 12.4 | | 12 - 15 13.6 - 30.5 440/65 - 800/65 | |
| in | mm | PR- | PR- | | |
| 3/8 | 10 | 110 | 122 | | |
| 3/4 | 20 | 120 | 180 | | |
| 1 1/2 | 40 | 180 | 182 | | |
| 3 1/2 | 90 | - | 184 | | |
| 5 1/4 | 130 | - | 186 | | |

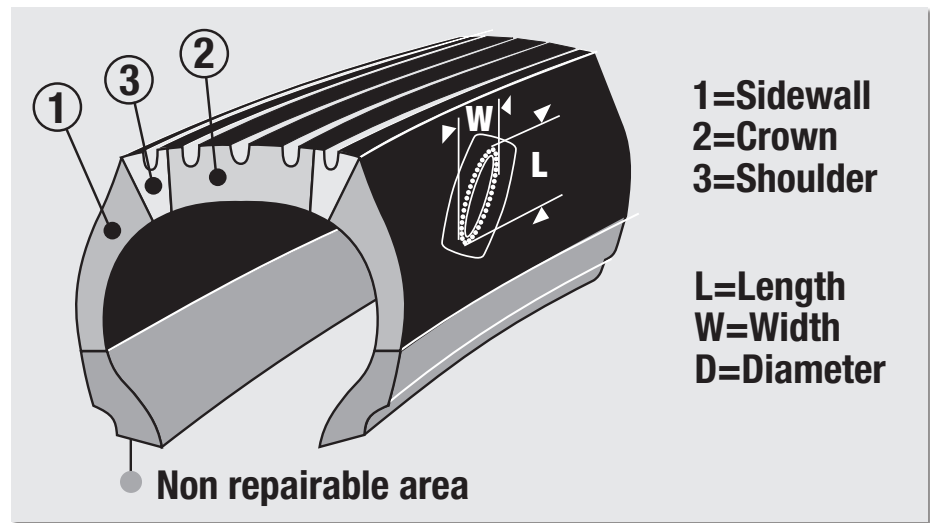

Must be installed using PREMA Chemicals and Cements.
Injury must be filled with appropriate PREMA repair materials.

These Repair Charts reflect International Repair Standards, determined on the basis of practical experience, bench checks, and laboratory tests. THEY NEITHER INCORPORATE NOR ARE INTENDED AS A REFERENCE TO LOCAL, STATE, OR NATIONAL STANDARDS THAT MAY EXIST IN YOUR COMMUNITY. Stay within the limitation for repairable injuries indicated by the charts. When repairing a tire, it is imperative that a complete inspection be conducted to ensure that the tire is fit to be repaired and safely returned to service. Always follow proper repair procedures as illustrated in the appropriate PREMA Repair Manual(s). No tire can be safely repaired without demounting it from the rim, giving it a complete inspection, and properly repairing the injury with the appropriate inside repair unit and filler material.



RADIAL Patch Application

Locate the cause that leads to the tire damage and remove any remaining foreign objects. Demount the tire from the rim and inspect the inside of the tire thoroughly. After determining the reparability of the tire, mark the area and prove the reparability of the injury, before starting the repair procedure. The prepared repair channel has to be filled with the appropriate repair material.

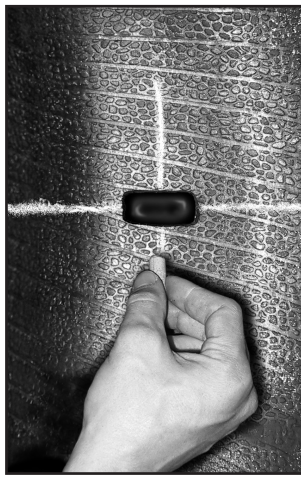

4. Draw auxiliary lines through the center of the injury. Mark out the centerlines on the repair.

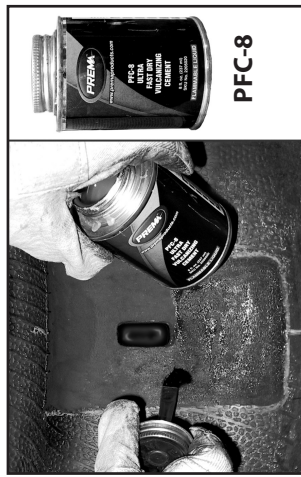

8. Evenly apply one coat of Prema Ultra Fast Dry Cement PFC to the buffed area by stippling the cement into the buffed surface. Allow to dry completely. DO NOT use any artificial means to dry.

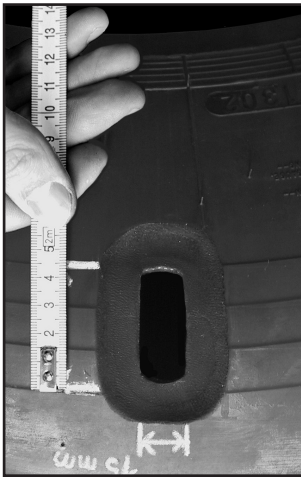

1. Measure the injury in Width, Length or max. Diameter.

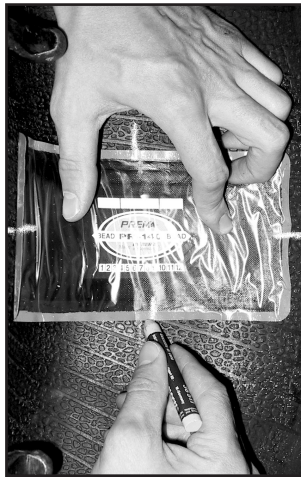

5. Centre the repair over the injury until the lines on the liner and the lines on the repair are coinciding. Mark the area around the repair with chalk.

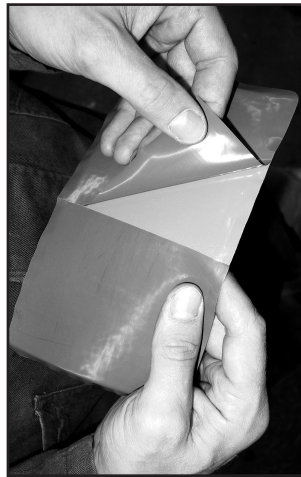

9. Remove the blue poly from the repair on both sides. Align the repair to the correct position and apply to the prepared area. Make sure not to touch/contaminate grey face gum surface.

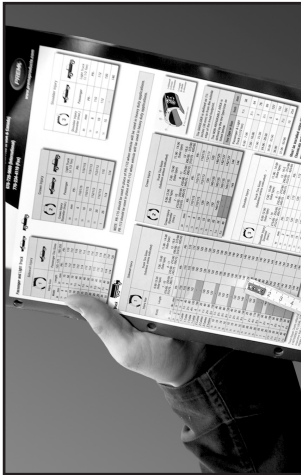

2. Select the suitable repair in accordance with the Application Chart. The prepared repair channel has to be filled with the appropriate repair material.

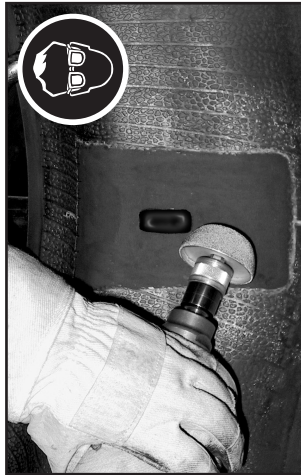

6. Use a smooth buffing tool to buff the liner inside the marked area. (Buffer should be max. 5000 rpm)



10. Stitch the repair onto the prepared area. Stitch from the center of the repair to the outside to remove any trapped air.



3. Remove contaminants and silicone from the innerliner of the tire prior to marking/buffing with PREMA Pre Buff Cleaner PPC.



7. Use a soft-bristled brass to remove the buffing dust. Also vacuum can be used



11. Use Prema Overbuff Sealant PLOS to cover the edges of the repair and coat the overbuff area of the liner.

Storage: The repairs should be stored in a dark, dry area at 25° C +/- 5° C (75° F +/- 10° F)

PREMA GmbH, Aspertscham 40, 94081 Fürstentzell, Germany, www.prema24.com